

**"Mounting Brackets"**

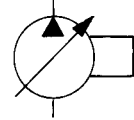

**Installation Drawing**

**Foot Type Mounting Brackets**

FOR PVV200/250-B1 PUMPS  
SAE "E" 4-BOLT PUMP MTG BRACKET

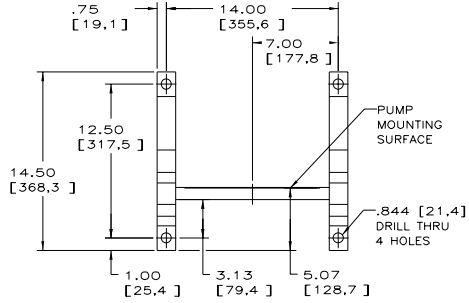

- NOTES:  
1) DIMENSIONS GIVEN IN INCHES/[MM]  
2) NET WEIGHT - 86 LBS (39 KG)  
3) FOR BASIC PUMP DIMENSIONS SEE:  
DS-47939A SAE MOUNT, USA CONNECTIONS  
DS-M47939A SAE MOUNT, METRIC CONNECTIONS

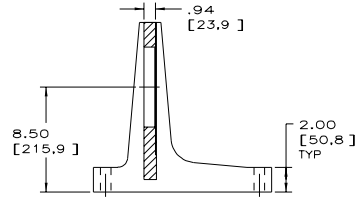
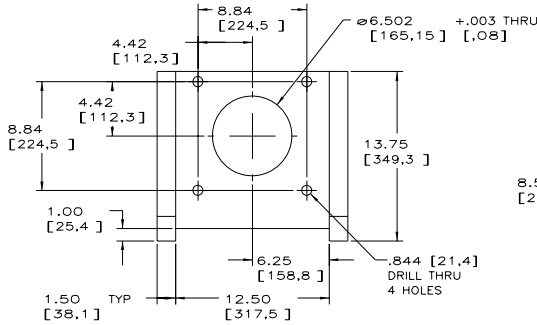
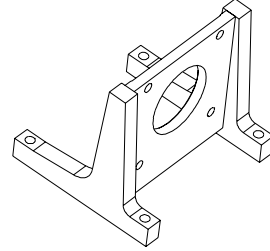

FOR PW540-B1 PUMPS  
ISO 250 4-BOLT PUMP MTG BRACKET

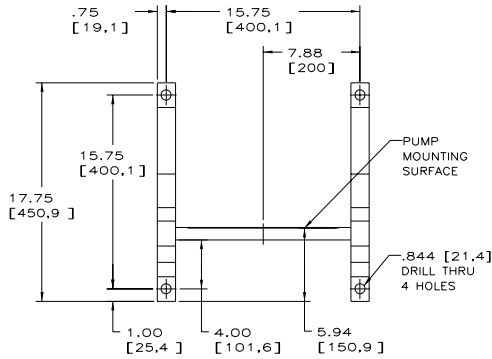

- NOTES:  
1) DIMENSIONS GIVEN IN INCHES/[MM]  
2) NET WEIGHT - 107 LBS (49 KG)  
3) FOR BASIC PUMP DIMENSIONS SEE:  
DS-47940A ISO MOUNT, USA CONNECTIONS  
DS-M47940A ISO MOUNT, METRIC CONNECTIONS

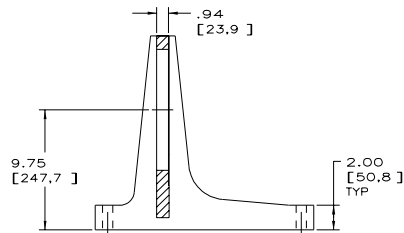
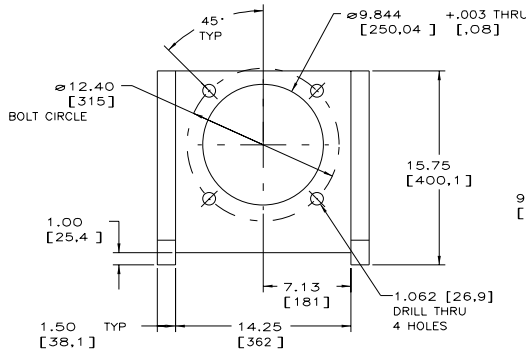
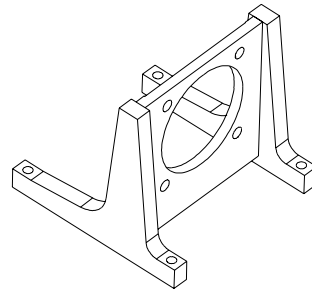

519152.sh.1