

HYDRAULIC CIRCUIT

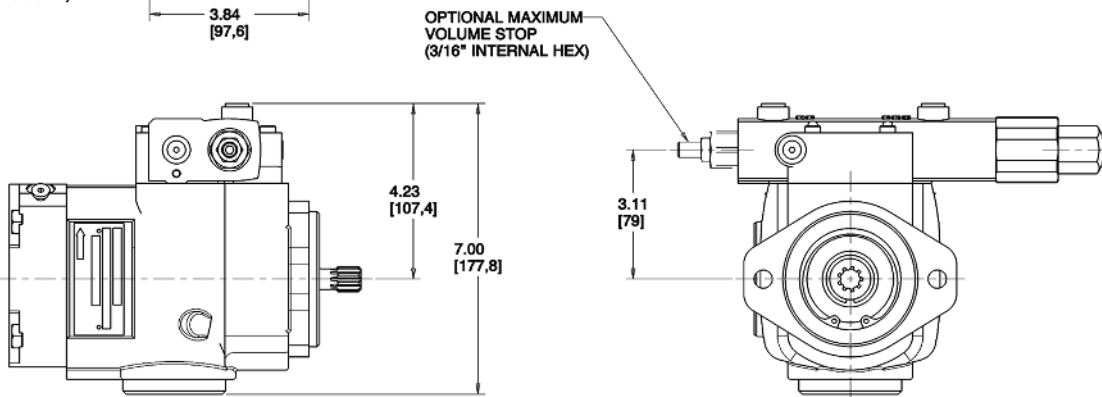
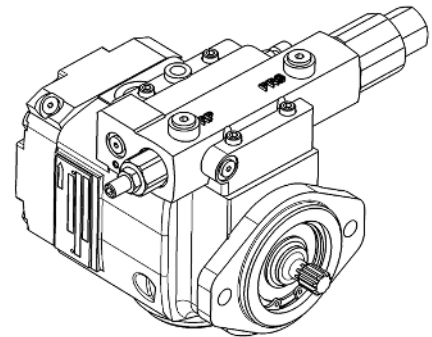
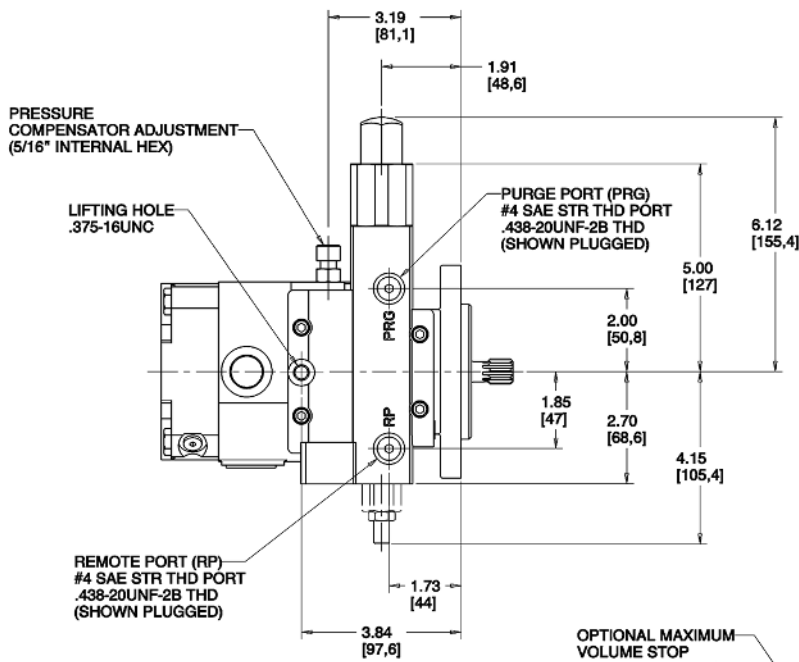

520012-110
Rev 1

FOR BASIC PUMP DIMENSIONS SEE PLANOGRAPHS:
DS-47480, DS-47481, DS-47482